

Cassidy Bunkie 40 (549x549)

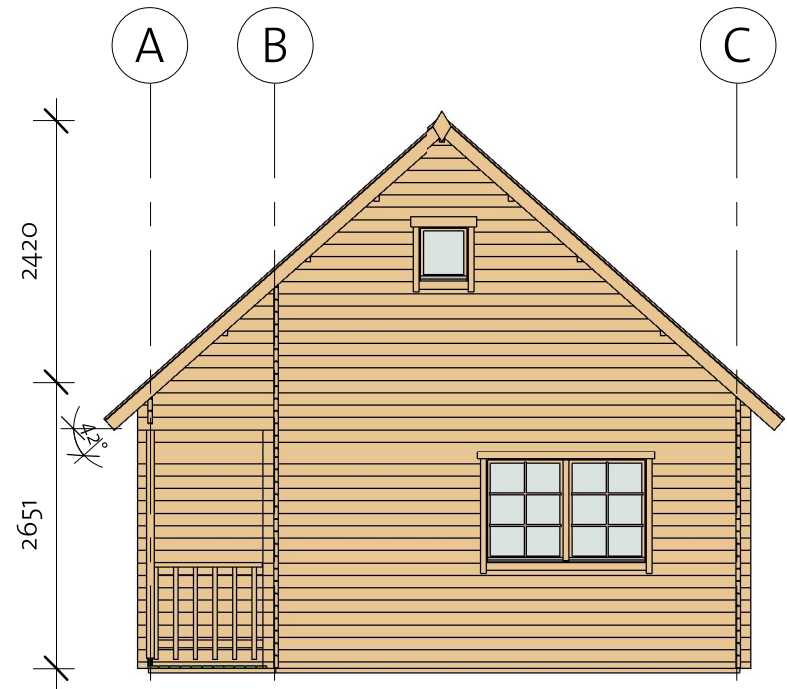

Cassidy Bunkie 40 (549x549)

Foundation

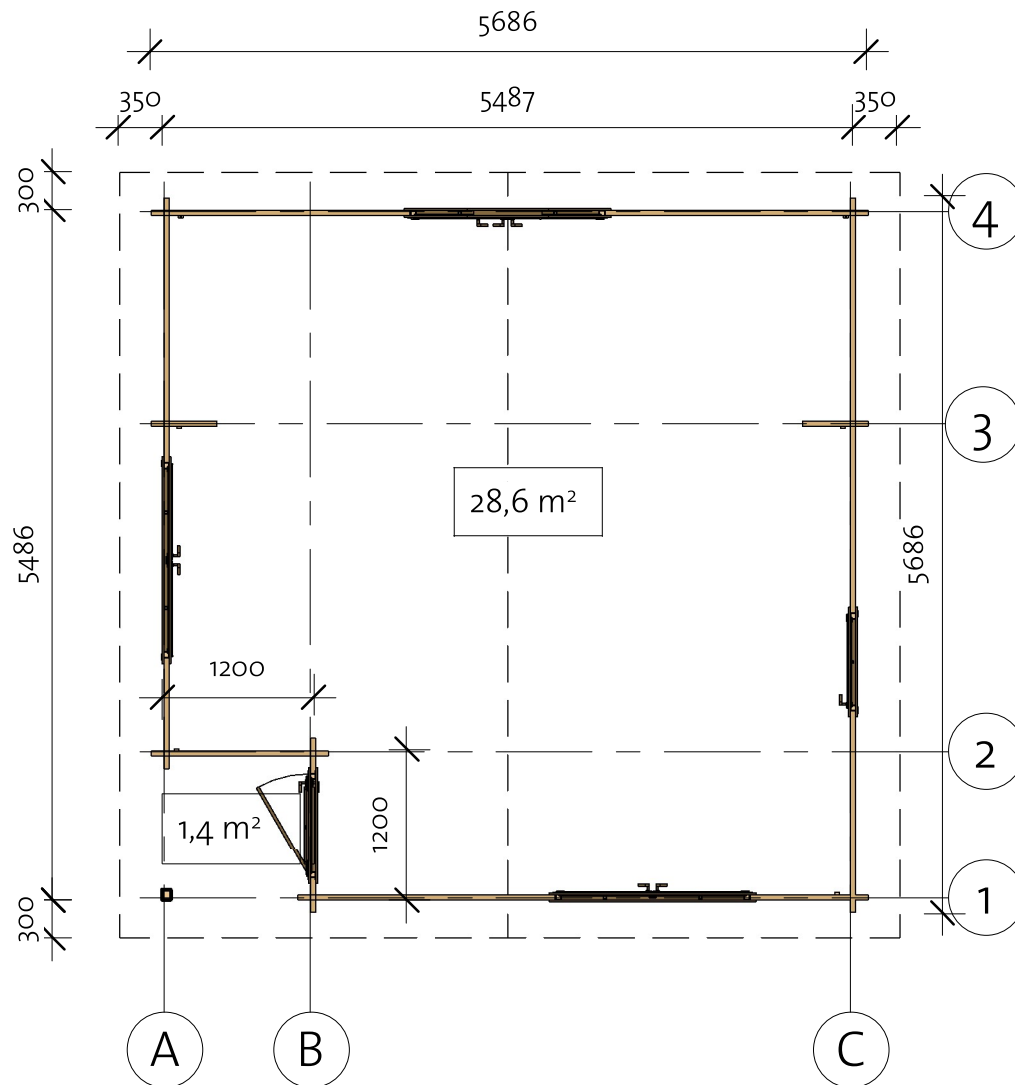
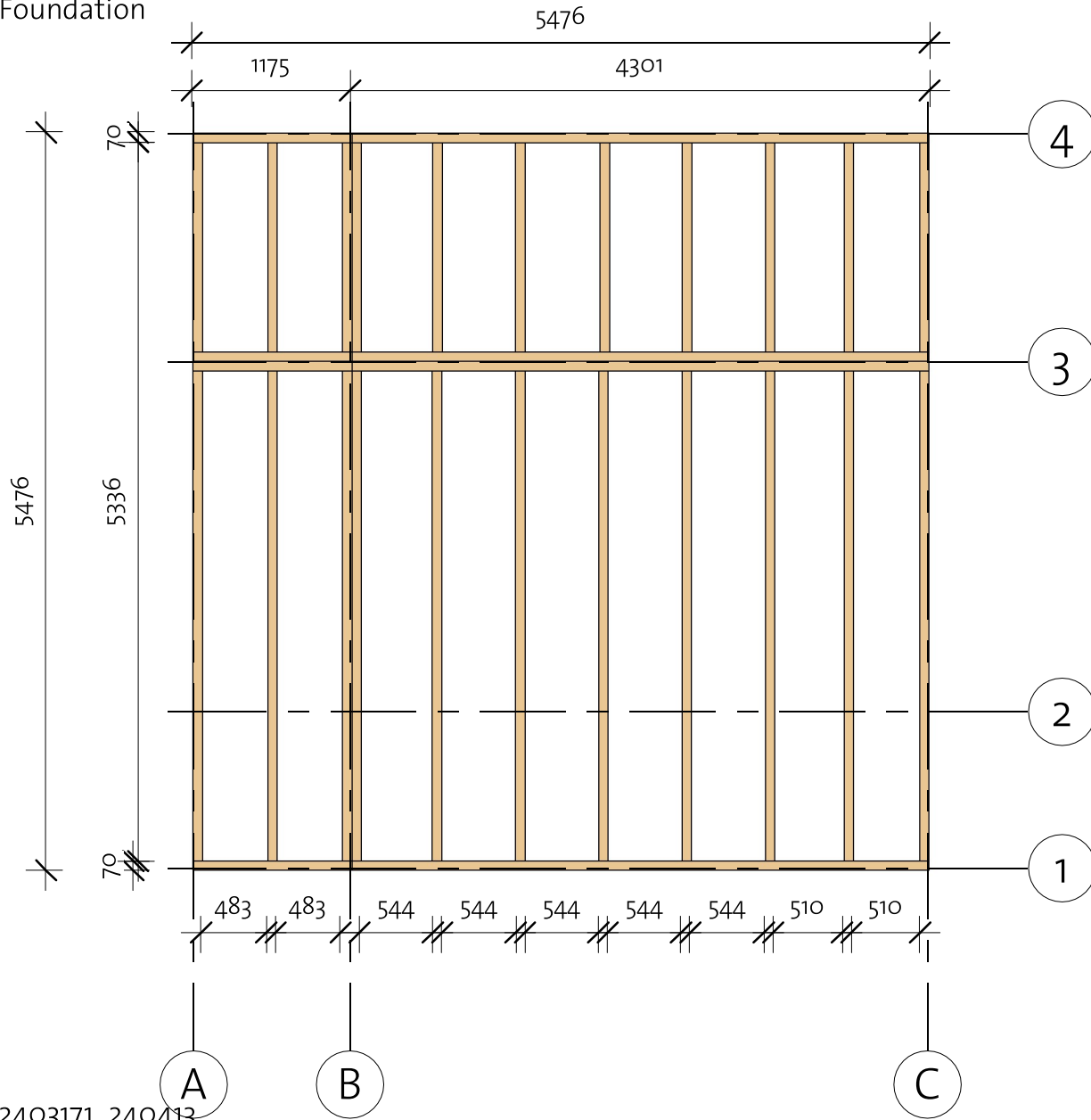

Impregnated foundation beams				
Mark	Type	Profile	Count	Length

IFB1	IFB 70x40		11	1564
IFB2	IFB 70x40		11	3632
IFB3	IFB 70x40		4	4301
IFB4	IFB 70x40		4	1175

Cassidy Bunkie 40 (549x549)

Floor Plan

① Baseboard

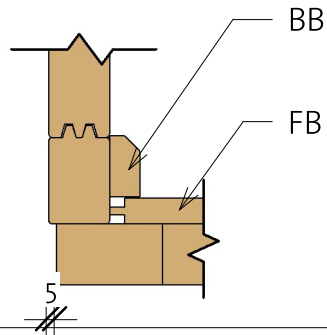

Floor Schedule

Mark	Type	Profile	Count	Length
------	------	---------	-------	--------

FB1	FB 17x114		48	4240
FB2	FB 17x114		38	1160

BB 1	BB 18x40		7	5600
------	----------	-------------------------------------------------------------------------------------	---	------

Terrace Schedule

TB	TB 21x95		11	1160
----	----------	-------------------------------------------------------------------------------------	----	------

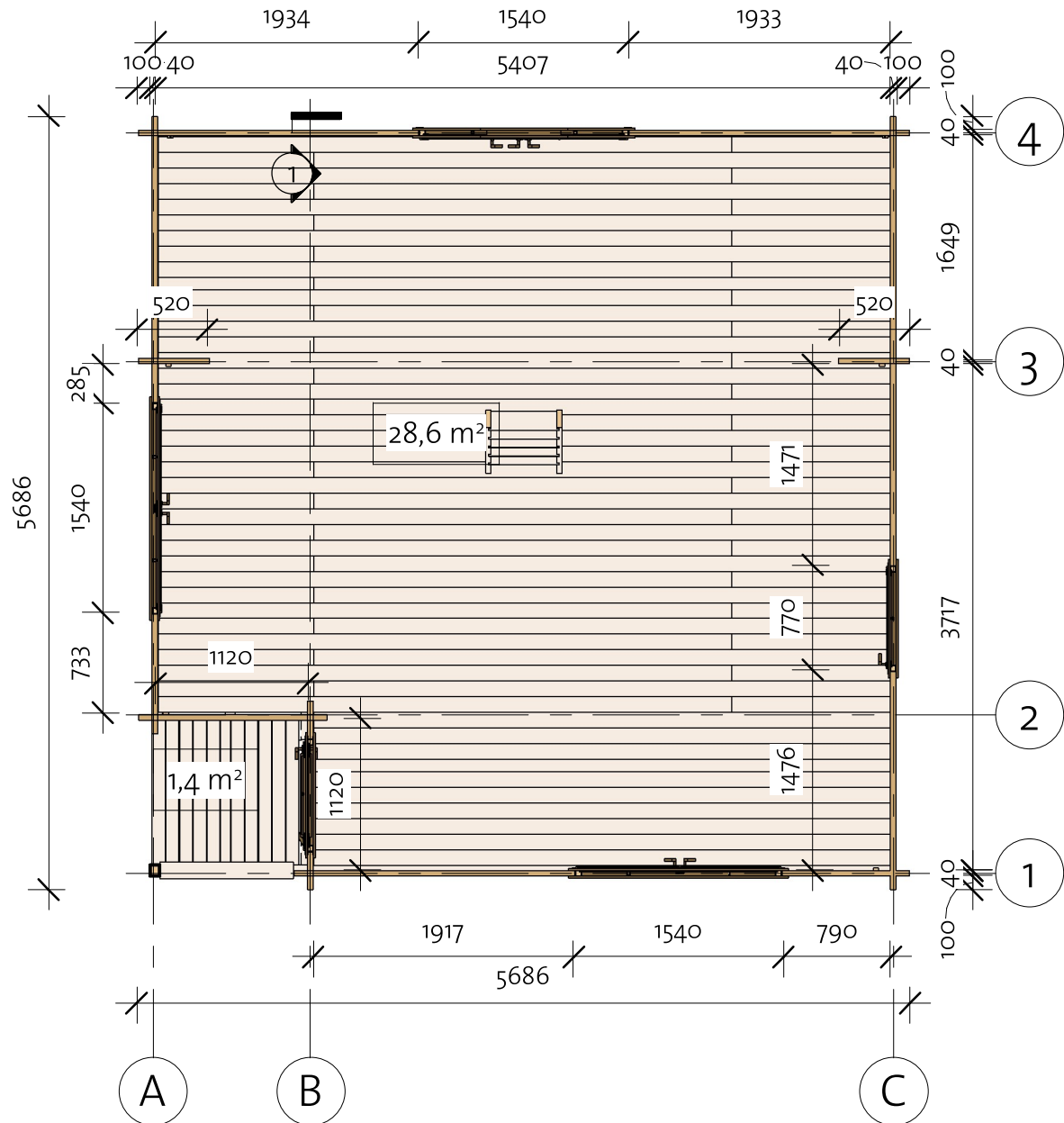

Cassidy Bunkie 40 (549x549)

Wall 1

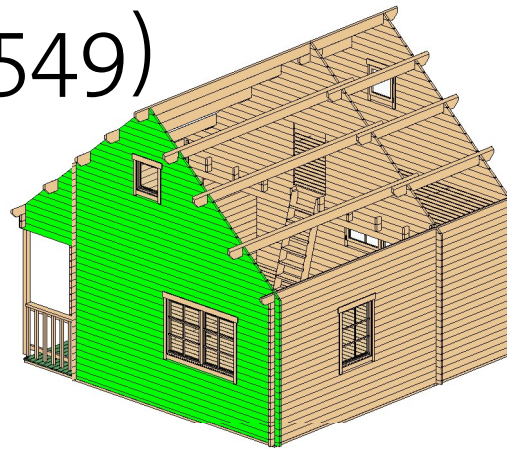

Log Profile Wall 1	
Profile	Profile

Log Profile Wall 1	
Profile	Profile

40x57	
-------	-----------------------------------------------------------------------------------

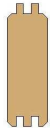
40x114	
--------	-----------------------------------------------------------------------------------

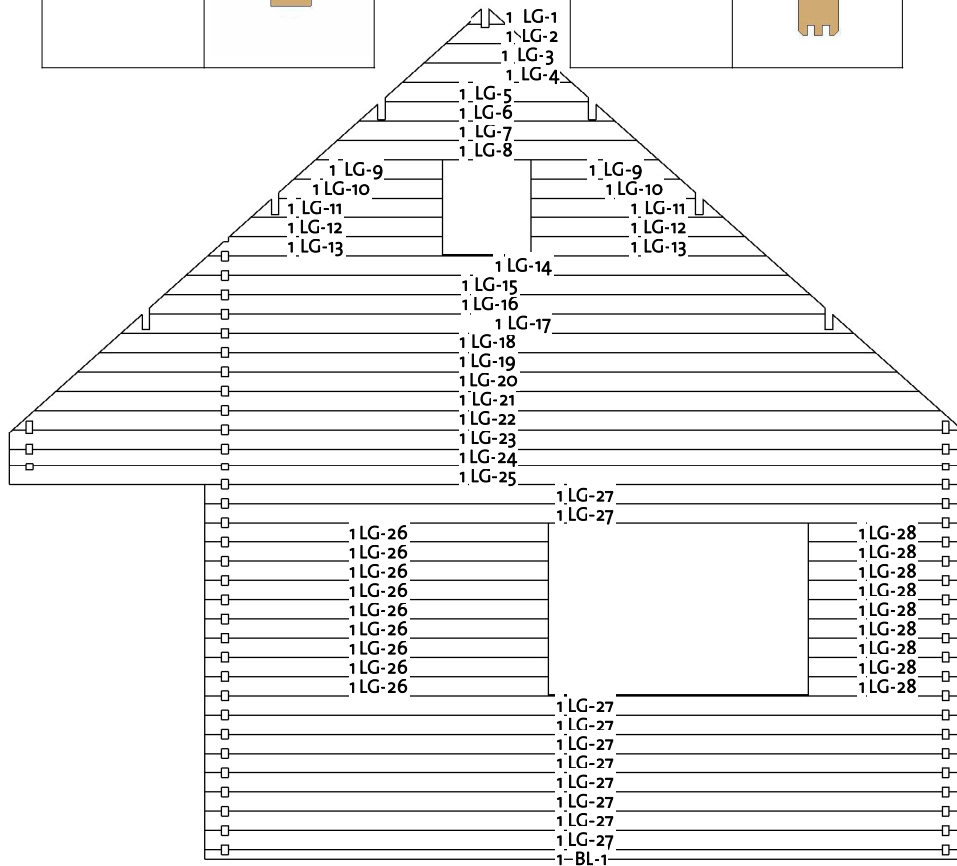

Wall 1			
Mark	Profile	Count	Cut Length

1BL-1	40x57	1	4526
1LG-1 *	40x114	1	251
1LG-2 *	40x114	1	508
1LG-3 *	40x114	1	765
1LG-4 *	40x114	1	1022
1LG-5 *	40x114	1	1225
1LG-6 *	40x114	1	1535
1LG-7 *	40x114	1	1792
1LG-8 *	40x114	1	2049
1LG-9 *	40x114	2	880
1LG-10 *	40x114	2	971
1LG-11 *	40x114	2	1137
1LG-12 *	40x114	2	1266
1LG-13 *	40x114	2	1394
1LG-14 *	40x114	1	3590

Wall 1			
Mark	Profile	Count	Cut Length

1LG-15 *	40x114	1	3847
1LG-16 *	40x114	1	4020
1LG-17 *	40x114	1	4361
1LG-18 *	40x114	1	4617
1LG-19 *	40x114	1	4874
1LG-20 *	40x114	1	5131
1LG-21 *	40x114	1	5388
1LG-22 *	40x114	1	5645
1LG-23 *	40x114	1	5686
1LG-24	40x114	1	5686
1LG-25	40x114	1	5686
1LG-26	40x114	9	2056
1LG-27	40x114	10	4526
1LG-28	40x114	9	930

* Gable - delivered premounted

*

Cassidy Bunkie 40 (549x549)

Wall 2

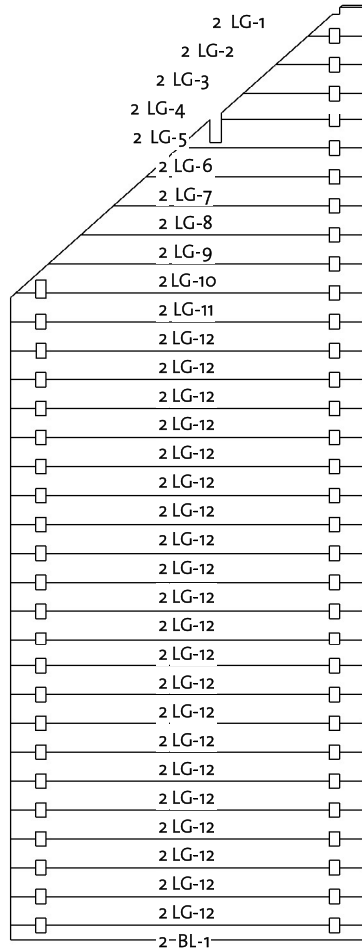
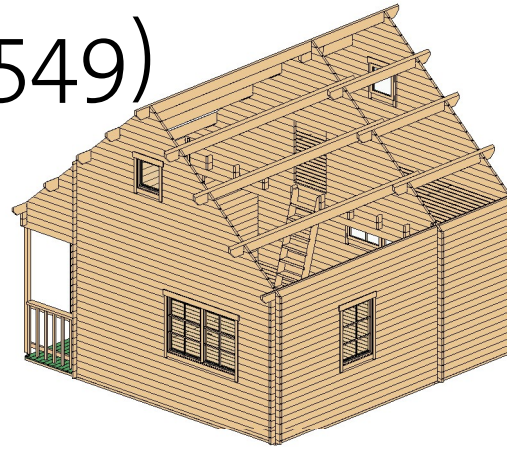

Wall 2			
Mark	Profile	Count	Cut Length
2BL-1	40X57	1	1400
2LG-1 *	40X114	1	224
2LG-2 *	40X114	1	352
2LG-3 *	40X114	1	480
2LG-4 *	40X114	1	567
2LG-5 *	40X114	1	737
2LG-6 *	40X114	1	866
2LG-7 *	40X114	1	994
2LG-8 *	40X114	1	1123
2LG-9 *	40X114	1	1251
2LG-10*	40X114	1	1379
2LG-11*	40X114	1	1400
2LG-12	40X114	21	1400

Log Profile Wall 2	
Profile	Profile

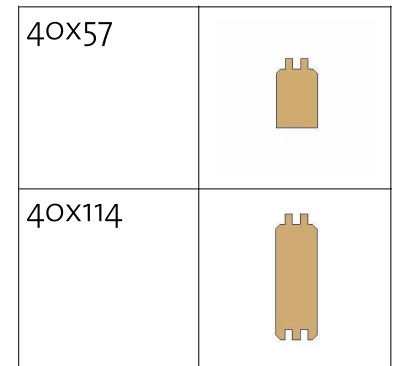

Cassidy Bunkie 40 (549x549)

Wall 3

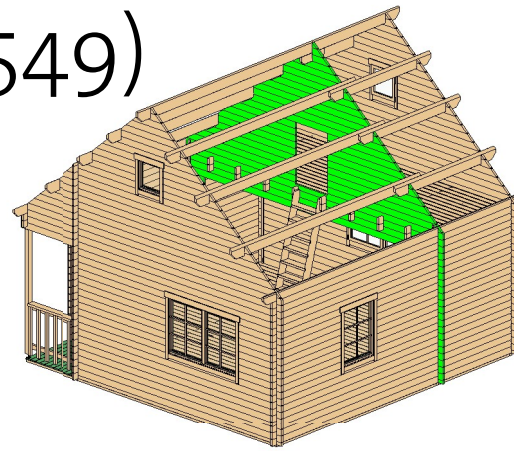

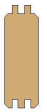
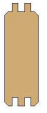
Log Profile Wall 3	
Profile	Profile
40X57	
40X114	

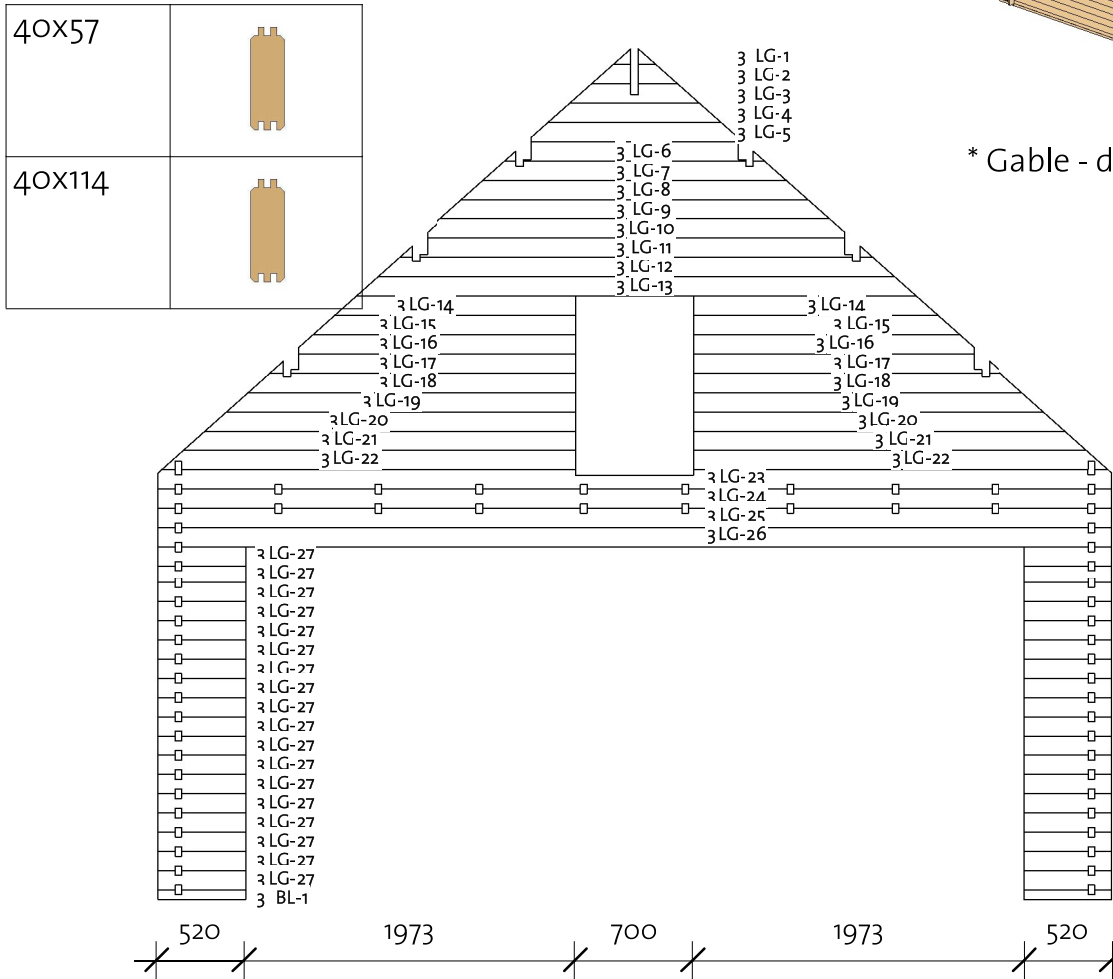

* Gable - delivered premounted

Wall 3			
Mark	Profile	Count	Cut Length



3BL-1	40X57	2	520
3LG-1 *	40X114	1	251
3LG-2 *	40X114	1	508
3LG-3 *	40X114	1	765
3LG-4 *	40X114	1	1022
3LG-5 *	40X114	1	1225
3LG-6 *	40X114	1	1535
3LG-7 *	40X114	1	1792
3LG-8 *	40X114	1	2049
3LG-9 *	40X114	1	2306
3LG-10 *	40X114	1	2487
3LG-11 *	40X114	1	2820
3LG-12 *	40X114	1	3076
3LG-13 *	40X114	1	3333
3LG-14 *	40X114	2	1445
3LG-15 *	40X114	2	1573
3LG-16 *	40X114	2	1660
3LG-17 *	40X114	2	1830
3LG-18 *	40X114	2	1959
3LG-19 *	40X114	2	2087
3LG-20 *	40X114	2	2216
3LG-21 *	40X114	2	2344
3LG-22 *	40X114	2	2472
3LG-23 *	40X114	1	5686
3LG-24	40X114	1	5686
3LG-25	40X114	1	5686
3LG-26	40X114	1	5686
3LG-27	40X114	36	520

Cassidy Bunkie 40 (549x549)

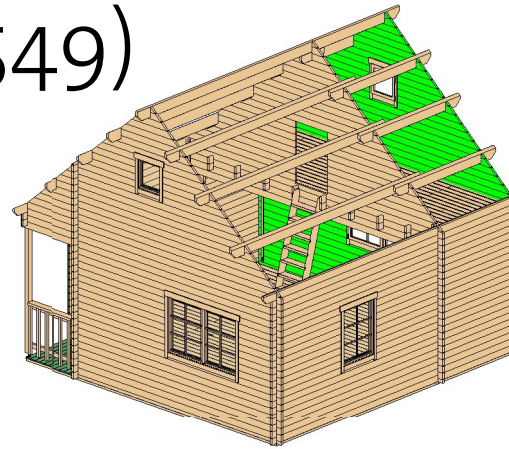
Wall 4



Log Profile Wall 4	
Profile	Profile

40X57	
40X114	

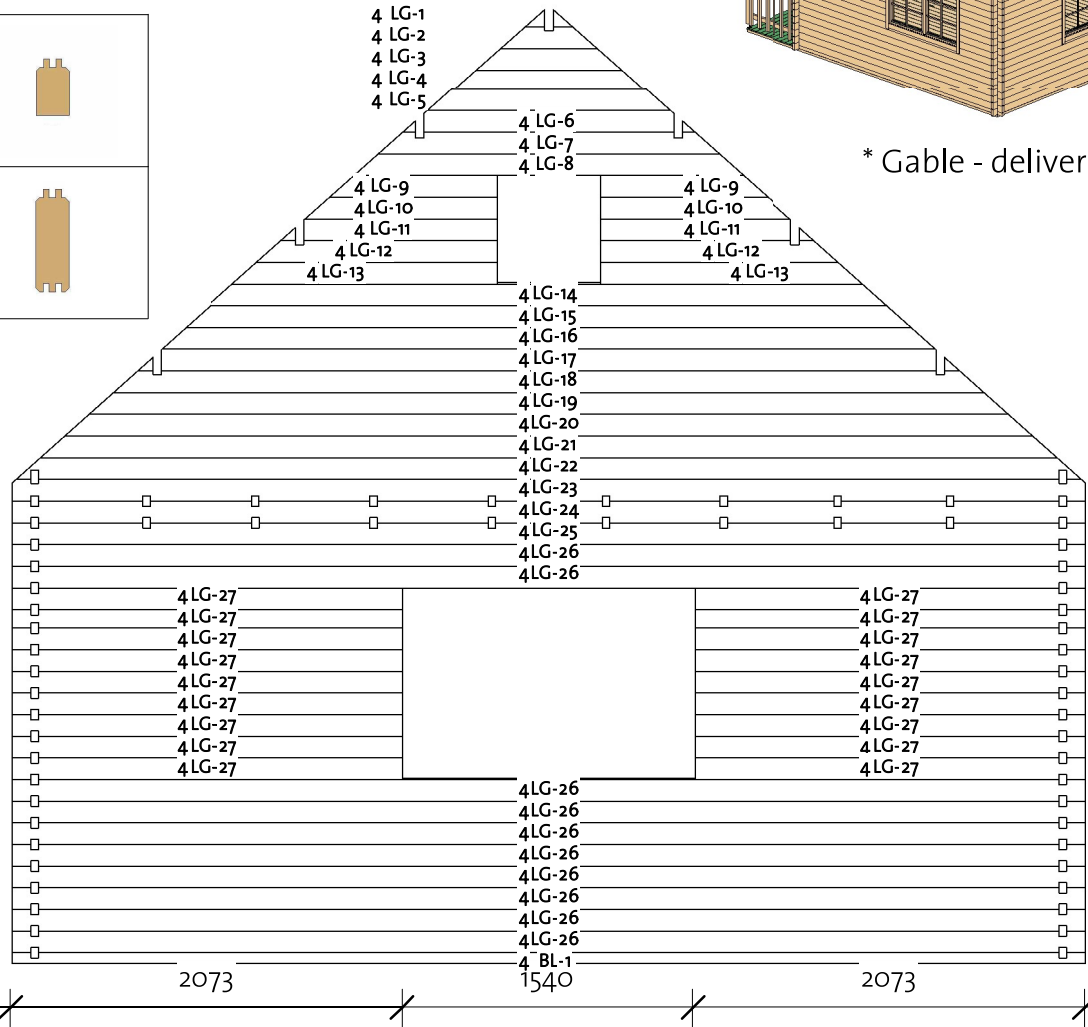

Wall 4			
Mark	Profile	Count	Cut Length

4BL-1	40X57	1	5686
4LG-1 *	40X114	1	251
4LG-2 *	40X114	1	508
4LG-3 *	40X114	1	765
4LG-4 *	40X114	1	1022
4LG-5 *	40X114	1	1279
4LG-6 *	40X114	1	1535
4LG-7 *	40X114	1	1792
4LG-8 *	40X114	1	2049
4LG-9 *	40X114	2	880
4LG-10 *	40X114	2	1009
4LG-11 *	40X114	2	1137
4LG-12 *	40X114	2	1266
4LG-13 *	40X114	2	1394
4LG-14 *	40X114	1	3590
4LG-15 *	40X114	1	3847
4LG-16 *	40X114	1	4104
4LG-17 *	40X114	1	4361
4LG-18 *	40X114	1	4617
4LG-19 *	40X114	1	4874
4LG-20 *	40X114	1	5131
4LG-21 *	40X114	1	5388
4LG-22 *	40X114	1	5645
4LG-23 *	40X114	1	5686
4LG-24	40X114	1	5686
4LG-25	40X114	1	5686
4LG-26	40X114	10	5686
4LG-27	40X114	18	2073

Cassidy Bunkie 40 (549x549)

Wall A

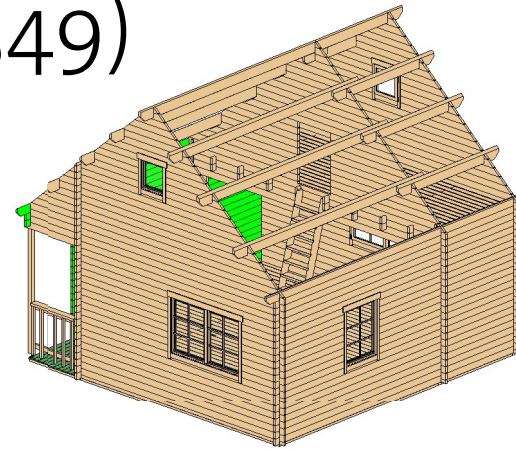

Wall A

Mark	Profile	Count	Cut Length
------	---------	-------	------------

ALG-1	40X114	11	4526
ALG-2	40X114	1	5686
ALG-3	40X114	1	5686
ALG-4	40X114	9	2114
ALG-5	40X114	9	873
ATL-1	40X143	1	2009
ATL-2	40X143	1	4077

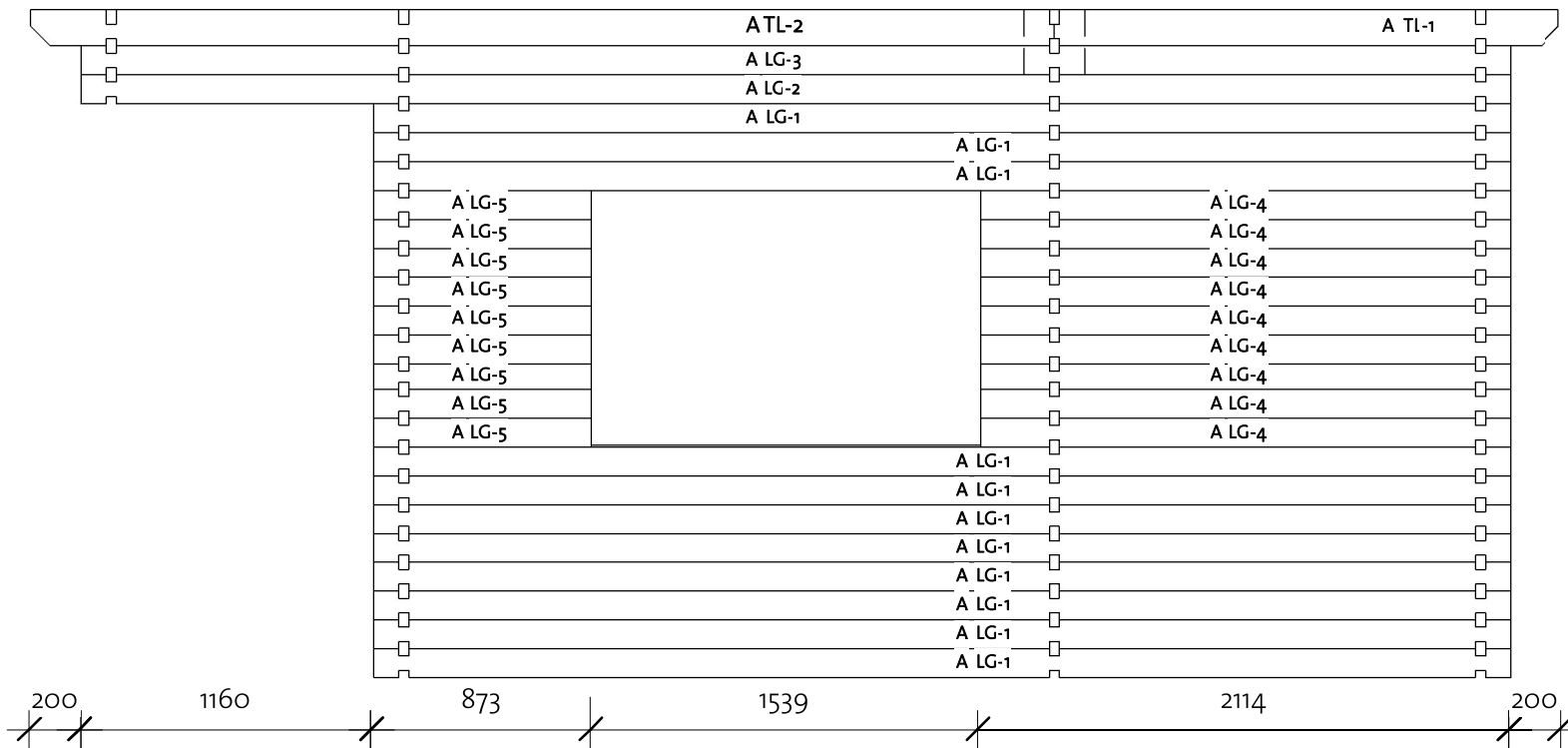

Log Profile Wall A

Profile	Profile
---------	---------

40X114

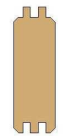

40X143

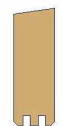

Cassidy Bunkie 40 (549x549)

Wall B

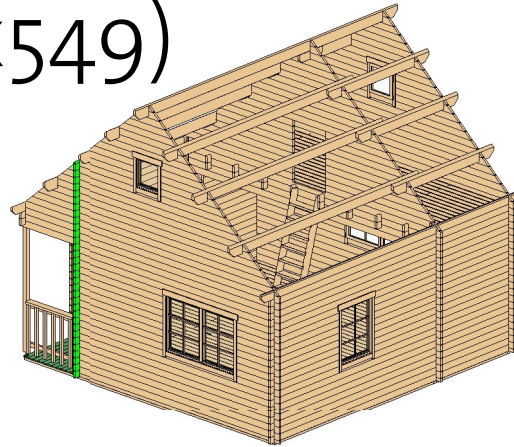

Wall B			
Mark	Profile	Count	Cut Length

BLG-1	40X114	14	1400
BLG-2	40X114	1	1400
BLG-3	40X114	34	275
BTL-1	40X53	1	1400

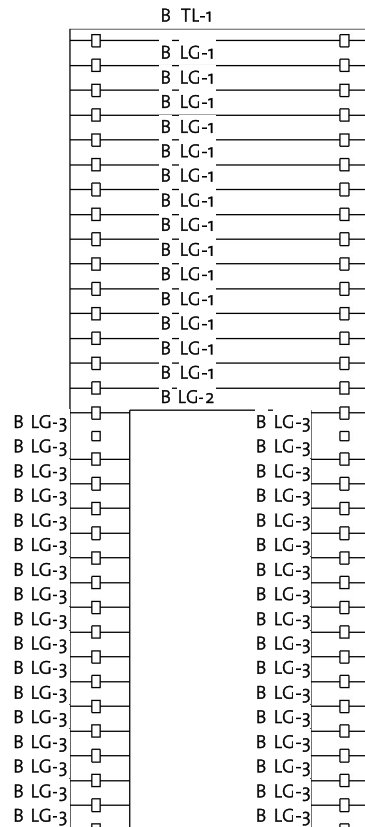

Log Profile Wall B	
Profile	Profile

40X114	
40X53	

Cassidy Bunkie 40 (549x549)

Wall C

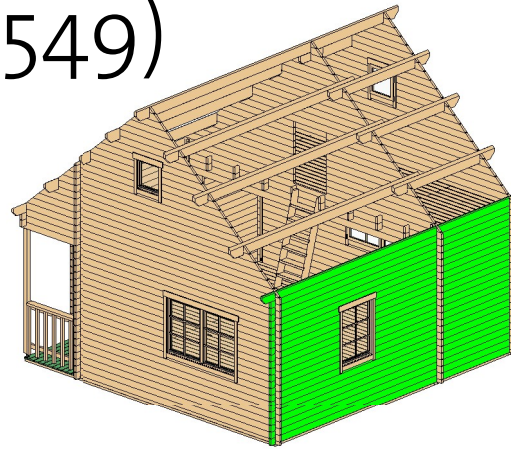

Wall C

Mark	Profile	Count	Cut Length
------	---------	-------	------------

CLG-1	40X114	12	5686
CLG-2	40X114	9	3300
CLG-3	40X114	9	1616
CLG-4	40X114	1	5686
CTL-1	40X143	1	2009
CTL-2	40X143	1	4077

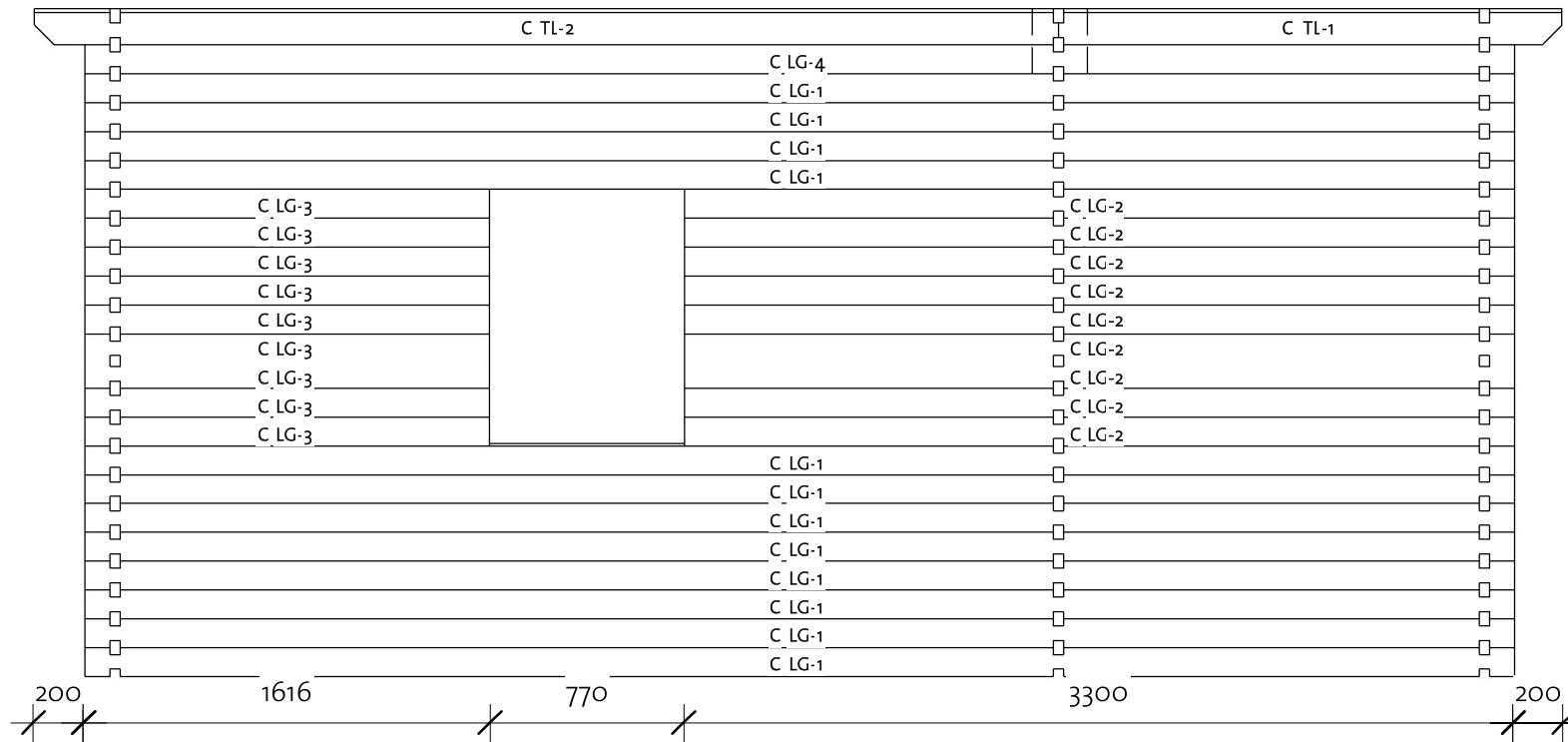

Log Profile Wall C

Profile	Profile
---------	---------

40X114

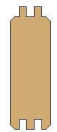

40X143

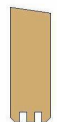

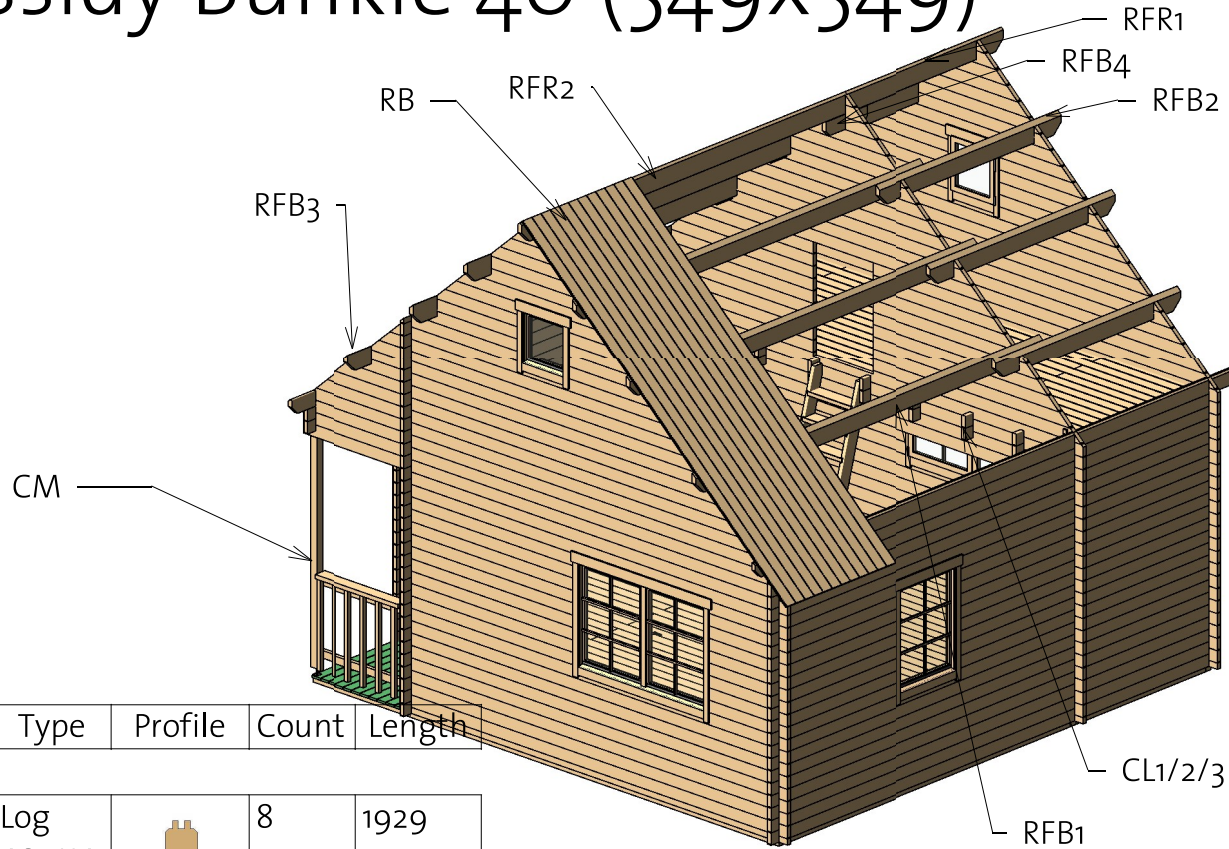

Cassidy Bunkie 40 (549x549)

Roof 1

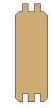

Mark	Type	Profile	Count	Length
------	------	---------	-------	--------

CL1	Log 40x114		8	1929
CL2	Log 40x114		8	1929
CL3	Beam 40x70		2	1648

Columns			
Mark	Profile	Count	Length

CM	Post 80x70	1	2184
----	------------	---	------

Roof				
Mark	Type	Profile	Count	Length

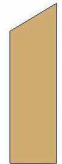
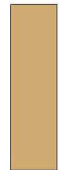
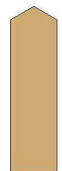
RB	17x114		108	4121
RFB1	Beam 45x195		5	4397
RFB2	Beam 45x195		6	2329
RFB3	Beam 45x195		1	4397
RFB4	Beam 45x143		1	520
RFR1	Ridge 45x195		1	2009
RFR2	Ridge 45x195		1	4077

Cassidy Bunkie 40 (549x549)

Roof 2

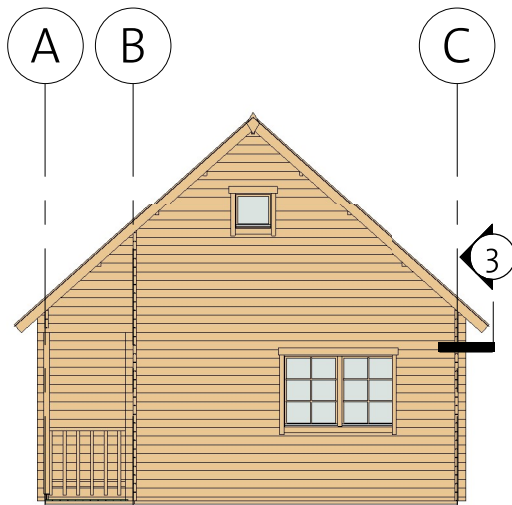
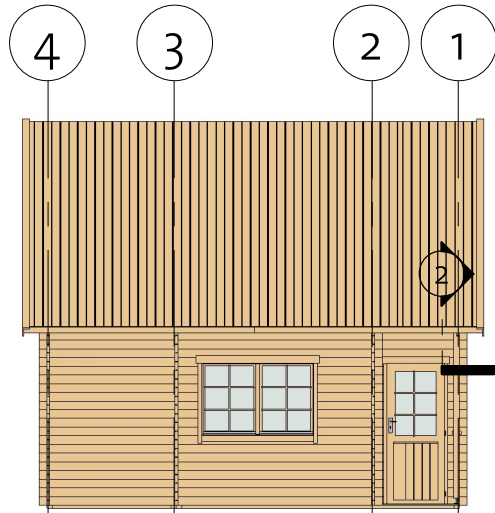

② Facia

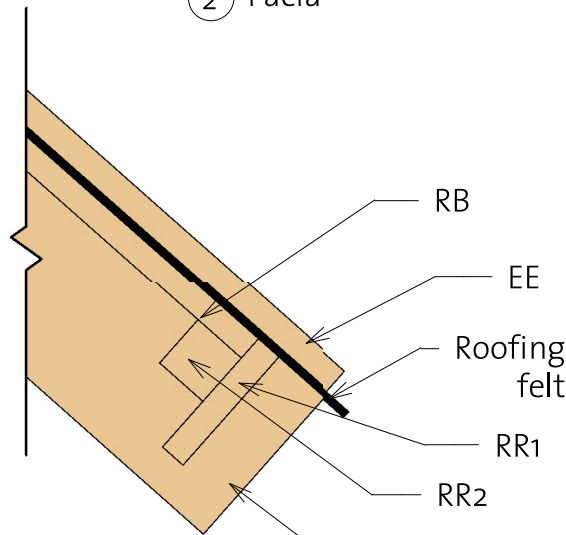

③ Roof Reinforcement

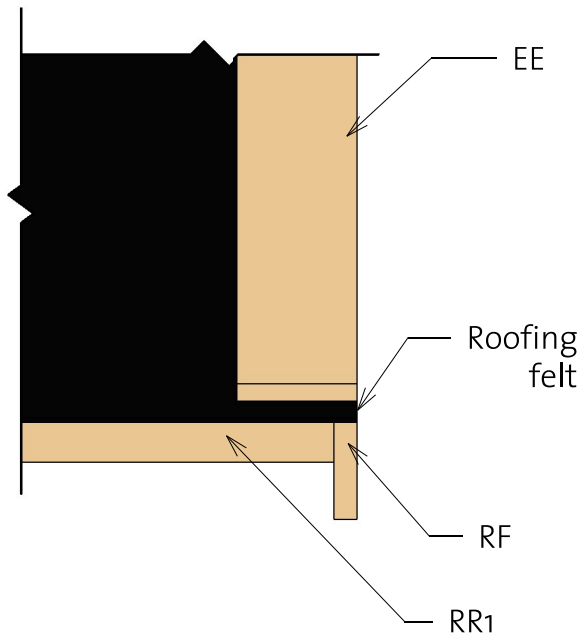

Fascia Schedule

Mark	Type	Profile	Count	Length
EE	Eave Edging 18x95		4	4194
RF	Roof Fascia 18x120		4	4194
RR1	Roof reinforcement 18x95		4	3043
RR2	Roof reinforcement 38x38		4	3043

Cassidy Bunkie 40 (549x549)

Second floor

Second floor 9,5 m2

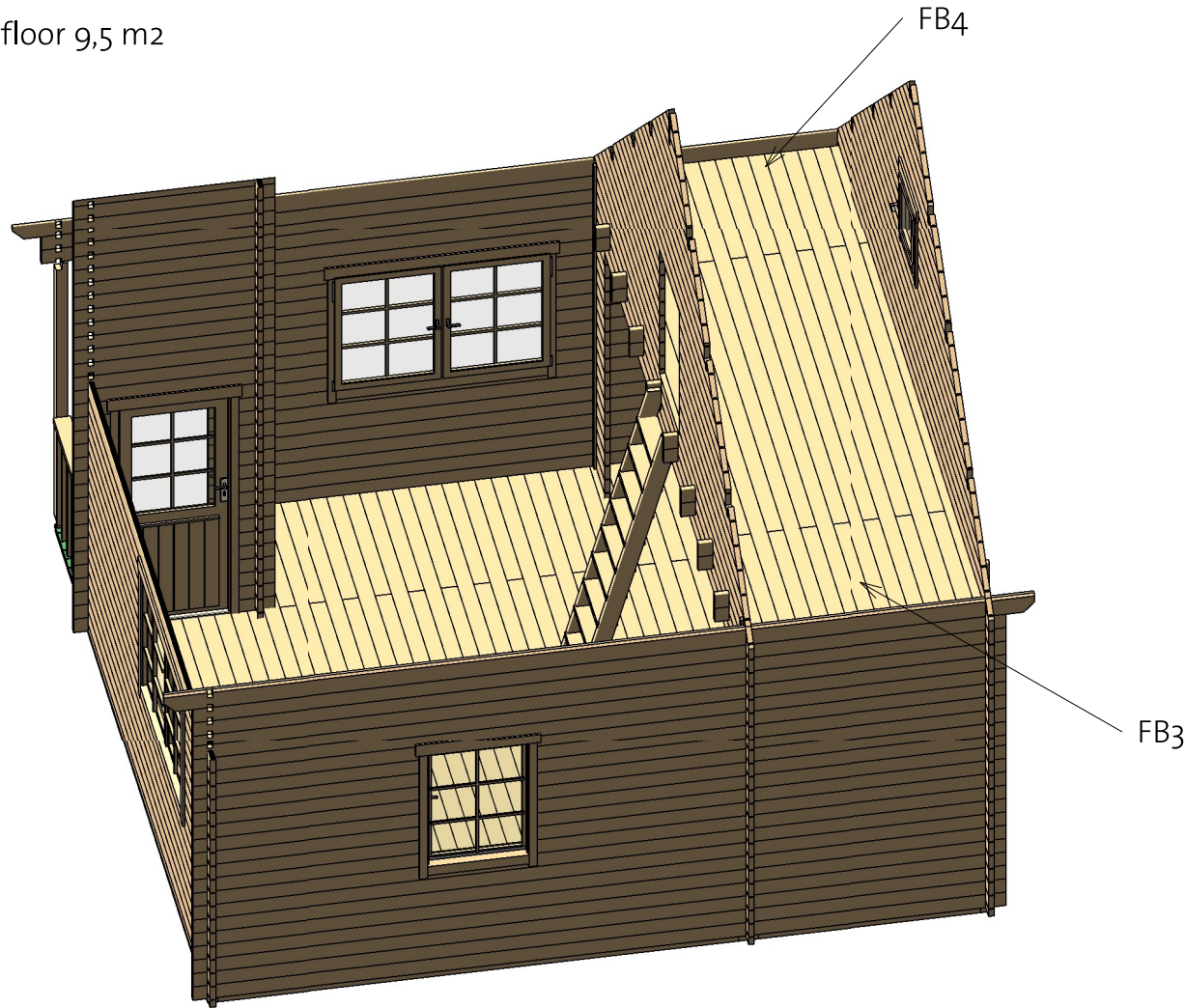





2 Floor Schedule				
Mark	Type	Profile	Count	Length

FB3	FB 17x114		16	4240
FB4	FB 17x114		16	1160

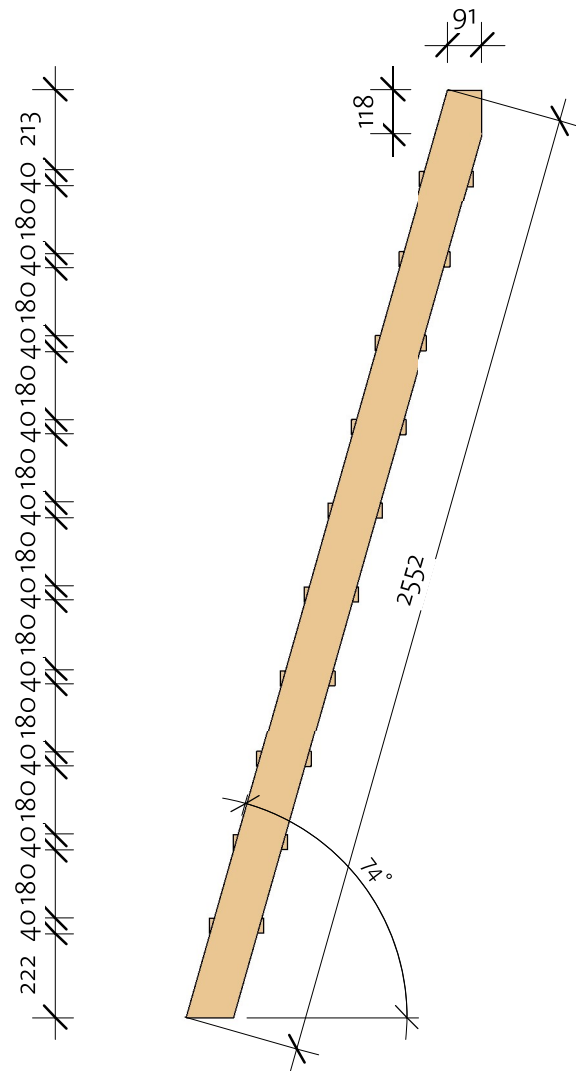
Cassidy Bunkie 40 (549x549)

Stair



Stairs				
Mark	Profile	Profile	Count	Cut Length
ST1L	Stair 40X120		1	2577
ST1R	Stair 40X120		1	2577
ST2	Stair 40X143		10	520

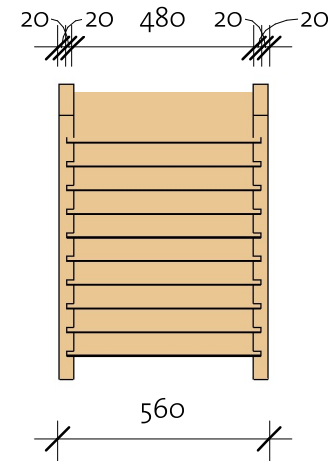

Cassidy Bunkie 40 (549x549)

Extras



Door Schedule				
Model	Type	Width	Height	Count
CD1R	Classic door 1 right	840	1890	1
DCB6	Door Crossbar 6	--	--	1
DB	Door beam 850 mm	40	12	1

Type	Count	Length
Windboard 18x40	4	2600
Windboard 18x40 2	2	2300

Type	Count
Romb	2



Fasteners/Extras		
Name	Type	Count

Hitblock	300-400 mm	
Adjustable post foot		1
Dowels	16,0x150	8
Bolts	M8x70	18
Nails	1,4 x 40	65
Screws	5,0 x 70	110
Screws	6,0 x 140	120
Screws	4,0 x 40	1500

Window Schedule				
Mark	Type	Width	Height	Count
CDW1	Classic double window 1	1530	990	3
CW1L	Classic window 1 left	765	990	1
CW12R	Classic window 12, full glass righth	540	540	2
WCB6	Windows Crossbar 6	--	--	7

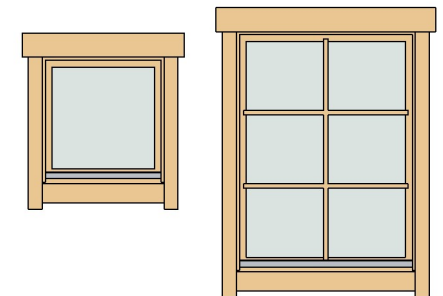
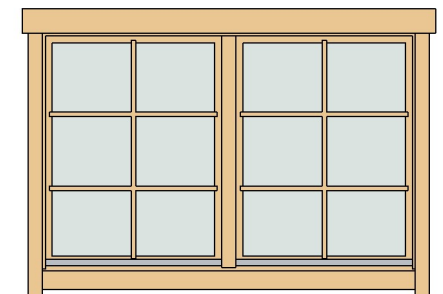





Cassidy Bunkie 40 (549x549)

List of all items 1

Impregnated foundation beams

Mark	Type	Profile	Count	Length
IFB1	IFB 70x40		11	1564
IFB2	IFB 70x40		11	3632
IFB3	IFB 70x40		4	4301
IFB4	IFB 70x40		4	1175

Roof

Mark	Type	Profile	Count	Length
RB	17x114		108	4121
RFB1	Beam 45x195		5	4397
RFB2	Beam 45x195		6	2329
RFB3	Beam 45x195		1	4397
RFB4	Beam 45x143		1	520
RFR1	Ridge 45x195		1	2009
RFR2	Ridge 45x195		1	4077

92403171_240413

Floor Schedule

Mark	Type	Profile	Count	Length
FB1	FB 17x114		48	4240
FB2	FB 17x114		38	1160





2 Floor Schedule

Mark	Type	Profile	Count	Length
FB3	FB 17x114		16	4240
FB4	FB 17x114		16	1160

Terrace Schedule

Mark	Type	Profile	Count	Length
TB	TB 21x95		11	1160

Fascia Schedule

Mark	Type	Profile	Count	Length
EE	Eave Edging 18x95		4	4194
RF	Roof Fascia 18x120		4	4194
RR1	Roof reinforce ment 18x95		4	3043
RR2	Roof reinforce ment 38x38		4	3043

Cassidy Bunkie 40 (549x549)

List of all items 2

Wall 1			
Mark	Profile	Count	Cut Length

1BL-1	40X57	1	4526
1LG-1 *	40X114	1	251
1LG-2 *	40X114	1	508
1LG-3 *	40X114	1	765
1LG-4 *	40X114	1	1022
1LG-5 *	40X114	1	1225
1LG-6 *	40X114	1	1535
1LG-7 *	40X114	1	1792
1LG-8 *	40X114	1	2049
1LG-9 *	40X114	2	880
1LG-10 *	40X114	2	971
1LG-11 *	40X114	2	1137
1LG-12 *	40X114	2	1266
1LG-13 *	40X114	2	1394
1LG-14 *	40X114	1	3590
1LG-15 *	40X114	1	3847
1LG-16 *	40X114	1	4020
1LG-17 *	40X114	1	4361
1LG-18 *	40X114	1	4617
1LG-19 *	40X114	1	4874
1LG-20 *	40X114	1	5131
1LG-21 *	40X114	1	5388
1LG-22 *	40X114	1	5645
1LG-23 *	40X114	1	5686
1LG-24	40X114	1	5686
1LG-25	40X114	1	5686
1LG-26	40X114	9	2056
1LG-27	40X114	10	4526
1LG-28	40X114	9	930

BB 1	BB 18x40		7	5600
------	----------	-------------------------------------------------------------------------------------	---	------

Wall 2			
Mark	Profile	Count	Cut Length



2BL-1	40X57	1	1400
2LG-1 *	40X114	1	224
2LG-2 *	40X114	1	352
2LG-3 *	40X114	1	480
2LG-4 *	40X114	1	567
2LG-5 *	40X114	1	737
2LG-6 *	40X114	1	866
2LG-7 *	40X114	1	994
2LG-8 *	40X114	1	1123
2LG-9 *	40X114	1	1251
2LG-10 *	40X114	1	1379
2LG-11 *	40X114	1	1400
2LG-12	40X114	21	1400

* Gable - delivered premounted

Wall A			
Mark	Profile	Count	Cut Length

ALG-1	40X114	11	4526
ALG-2	40X114	1	5686
ALG-3	40X114	1	5686
ALG-4	40X114	9	2114
ALG-5	40X114	9	873
ATL-1	40X143	1	2009
ATL-2	40X143	1	4077

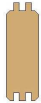
Mark	Type	Profile	Count	Length
------	------	---------	-------	--------

CL1	Log 40X114		8	1929
CL2	Log 40X114		8	1929
CL3	Beam 40X70		2	1648

Cassidy Bunkie 40 (549x549)

List of all items 3

Wall 3			
Mark	Profile	Count	Cut Length

3BL-1	40X57	2	520
3LG-1 *	40X114	1	251
3LG-2 *	40X114	1	508
3LG-3 *	40X114	1	765
3LG-4 *	40X114	1	1022
3LG-5 *	40X114	1	1225
3LG-6 *	40X114	1	1535
3LG-7 *	40X114	1	1792
3LG-8 *	40X114	1	2049
3LG-9 *	40X114	1	2306
3LG-10 *	40X114	1	2487
3LG-11 *	40X114	1	2820
3LG-12 *	40X114	1	3076
3LG-13 *	40X114	1	3333
3LG-14 *	40X114	2	1445
3LG-15 *	40X114	2	1573
3LG-16 *	40X114	2	1660
3LG-17 *	40X114	2	1830
3LG-18 *	40X114	2	1959
3LG-19 *	40X114	2	2087
3LG-20 *	40X114	2	2216
3LG-21 *	40X114	2	2344
3LG-22 *	40X114	2	2472
3LG-23 *	40X114	1	5686
3LG-24	40X114	1	5686
3LG-25	40X114	1	5686
3LG-26	40X114	1	5686
3LG-27	40X114	36	520

Wall 4			
Mark	Profile	Count	Cut Length

4BL-1	40X57	1	5686
4LG-1 *	40X114	1	251
4LG-2 *	40X114	1	508
4LG-3 *	40X114	1	765
4LG-4 *	40X114	1	1022
4LG-5 *	40X114	1	1279
4LG-6 *	40X114	1	1535
4LG-7 *	40X114	1	1792
4LG-8 *	40X114	1	2049
4LG-9 *	40X114	2	880
4LG-10 *	40X114	2	1009
4LG-11 *	40X114	2	1137
4LG-12 *	40X114	2	1266
4LG-13 *	40X114	2	1394
4LG-14 *	40X114	1	3590
4LG-15 *	40X114	1	3847
4LG-16 *	40X114	1	4104
4LG-17 *	40X114	1	4361
4LG-18 *	40X114	1	4617
4LG-19 *	40X114	1	4874
4LG-20 *	40X114	1	5131
4LG-21 *	40X114	1	5388
4LG-22 *	40X114	1	5645
4LG-23 *	40X114	1	5686
4LG-24	40X114	1	5686
4LG-25	40X114	1	5686
4LG-26	40X114	10	5686
4LG-27	40X114	18	2073

* Gable - delivered premounted

Cassidy Bunkie 40 (549x549)

List of all items 4

Wall B			
Mark	Profile	Count	Cut Length

BLG-1	40X114	14	1400
BLG-2	40X114	1	1400
BLG-3	40X114	34	275
BTL-1	40X53	1	1400



Wall C			
Mark	Profile	Count	Cut Length

CLG-1	40X114	12	5686
CLG-2	40X114	9	3300
CLG-3	40X114	9	1616
CLG-4	40X114	1	5686
CTL-1	40X143	1	2009
CTL-2	40X143	1	4077

Columns			
Mark	Profile	Count	Length

CM	Post 80x70	1	2184
----	------------	---	------





Stairs				
Mark	Profile	Profile	Count	Cut Length

ST1L	Stair 40X120		1	2577
ST1R	Stair 40X120		1	2577
ST2	Stair 40X143		10	520

Fence Schedule		
Type	Length	Count

Fence	1593	1
-------	------	---

Log profiles	
Profile	Profile

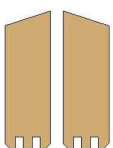
40X57	
40X53	
40X114	
40X114	
40X143	

Windboard

① Windboard Assembly 1

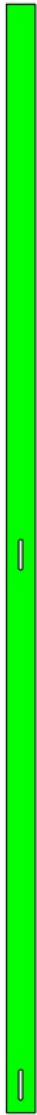

② Windboard Assembly 2

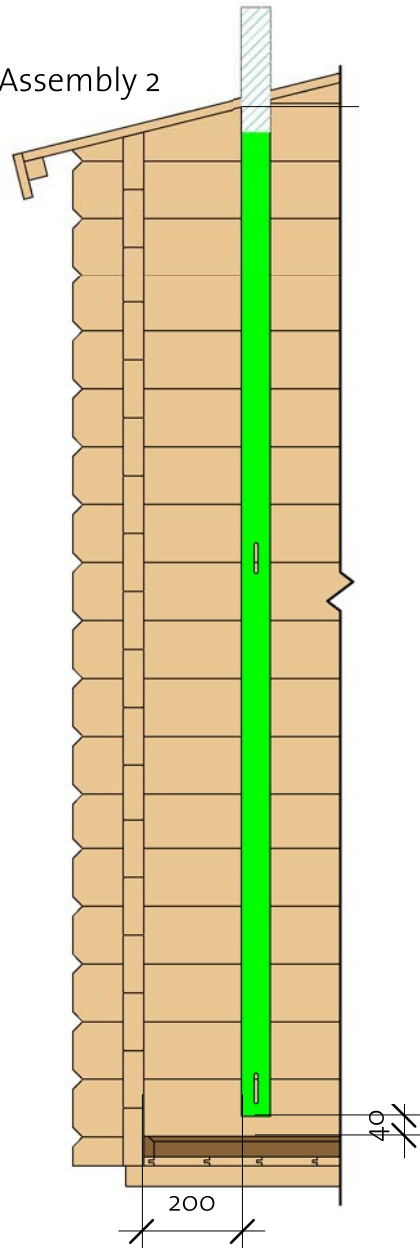

③ Windboard Assembly 3

